



MANAKULA VINAYAGAR INSTITUTE OF TECHNOLOGY

Approved by the AICTE, New Delhi - Affiliated to Pondicherry University
Accredited by NAAC WITH 'A' Grade and NBA (National Board of Accreditation)
Kalitheerthalkuppam, Puducherry - 605 107
Ph: 0413 2643007 / Website: www.mvit.edu.in



DEPARTMENT OF ELECTRONICS AND COMMUNICATION ENGINEERING

ICT Tools Used

SUBJECT NAME:	Digital Signal Processing
SUBJECT CODE:	ECT63
NAME OF THE FACULTY:	M.ZARINA BEGUM
ACADEMIC YEAR:	2025-26
BATCH OF THE STUDENTS:	2022-2026
NAME OF THE ICT TOOL USED:	MOODLE, WORDMINT,GIDMIND,QUIZZ
YEAR/SEM/SEC:	III/VI/ C
WHAT TYPE OF ACTIVITY:	
Moodle:	Notes, Quiz, Course Exit Survey, GATE questions link
Quizz and Mentimeter	Quiz
Gidmind	Mindmapping
Wordmint	Youtube videos and Quiz in between and Puzzle solving
Hot Seater	Brainstorming for finding the formulas and block diagrams in DSP
PPT	Voice over PPT and Notes

Moodle

Moodle Home Dashboard My courses MA Edit mode

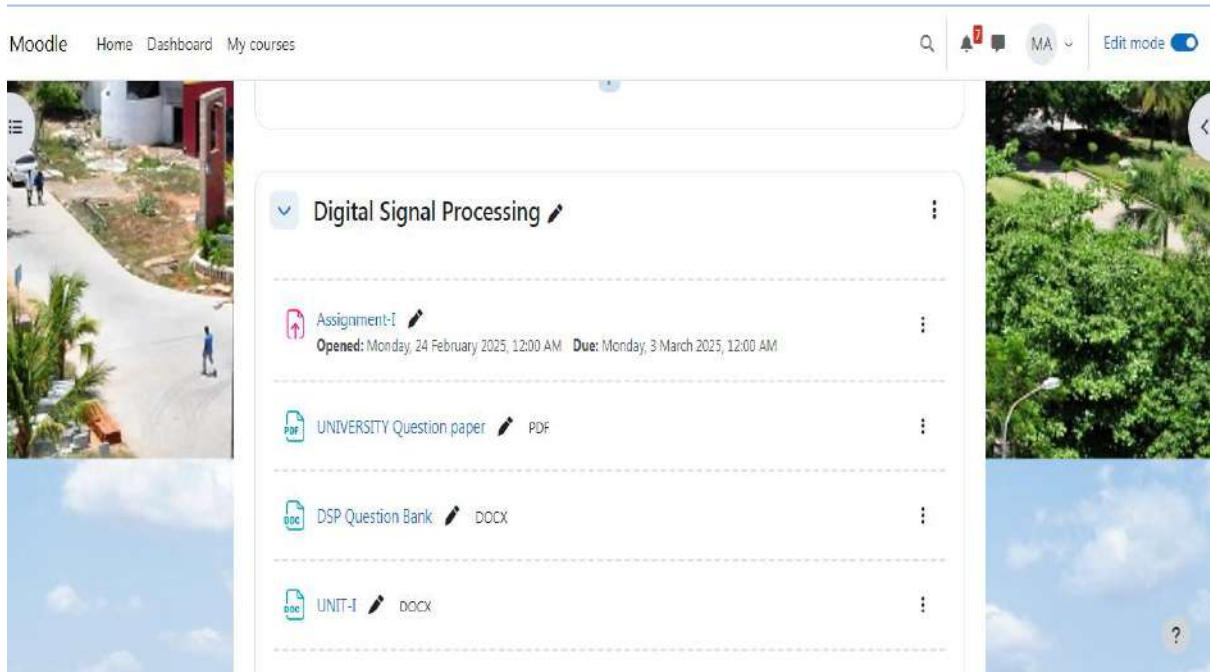

The screenshot shows a Moodle course page for 'Digital Signal Processing'. The course is expanded to show several items:

- Digital Signal Processing** (dropdown menu)
- Assignment-I** (document icon):
 - Opened: Monday, 24 February 2025, 12:00 AM
 - Due: Monday, 3 March 2025, 12:00 AM
- UNIVERSITY Question paper** (PDF icon)
- DSP Question Bank** (DOCX icon)
- UNIT-I** (DOCX icon)

Moodle Home Dashboard My courses MA Edit mode

24-25 ece sem 6 / Digital Signal Processing / PO -CO Quiz C Sec

PO -CO Quiz C Sec

Quiz Settings Questions Results Question bank More

[Continue the last preview](#)

Grading method: Highest grade

Attempts: 56

Your attempts

Attempt 1
Status In progress

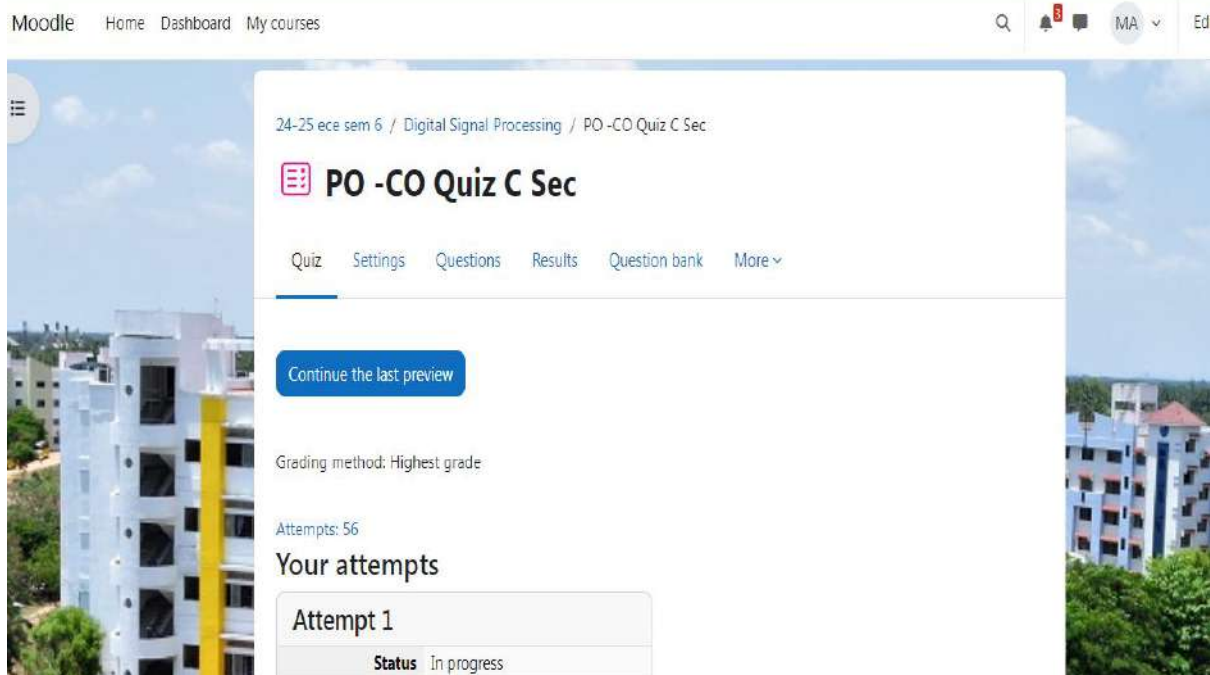

The screenshot shows a Moodle quiz page for 'PO -CO Quiz C Sec'. The page includes a navigation menu with 'Quiz', 'Settings', 'Questions', 'Results', 'Question bank', and 'More'. A blue button labeled 'Continue the last preview' is visible. Below this, the grading method is set to 'Highest grade' and the number of attempts is 56. A section titled 'Your attempts' contains a table with one row for 'Attempt 1', where the status is 'In progress'.

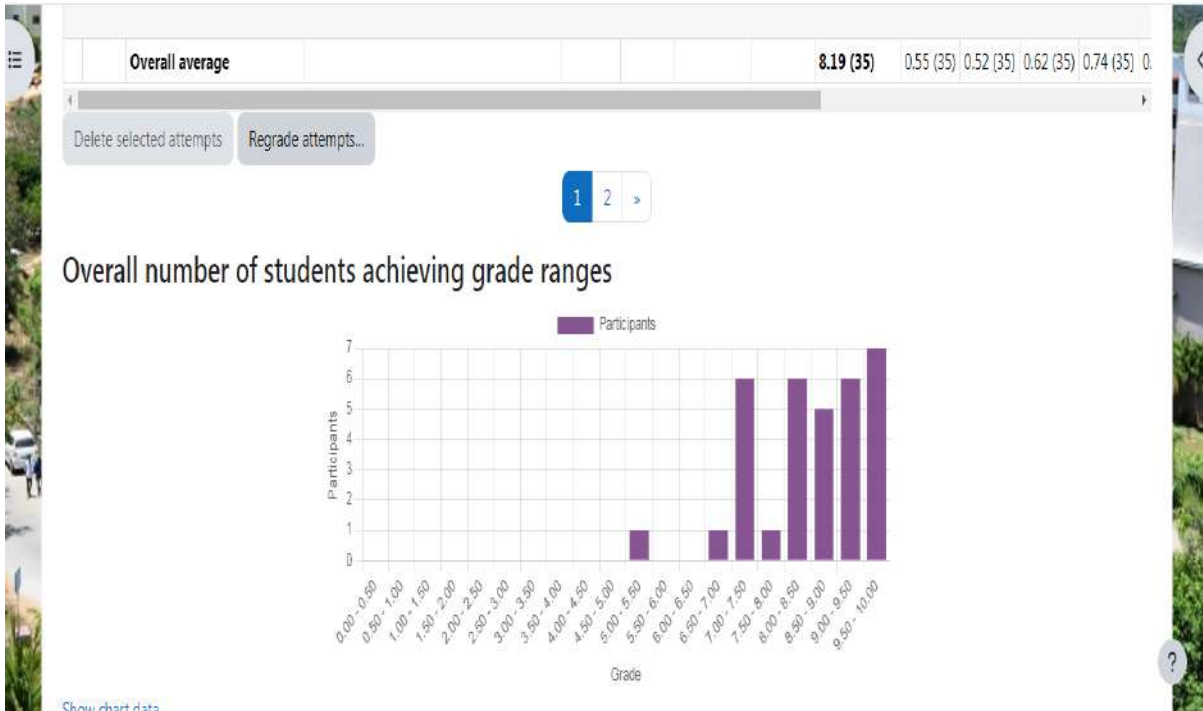

24-25 ece sem 6 / Digital Signal Processing / Course Exit Survey C Sec

FEEDBACK

Course Exit Survey C Sec

Feedback Settings Questions Templates Responses More

Edit questions Preview questions

Overview

Submitted answers: 52
Questions: 5

Moodle Usage for posting notes, quiz and survey

Last name	First name	Email address	Status	Duration	Grade/36.0
22TC0194	HARISH.B	harishece2022@mvit.edu.in	Finished	36 mins 55 secs	36
22TC0274	SAKTHIHARINI.T	sakthihariniece2022@mvit.edu.in	Finished	17 mins 55 secs	30
22TC0200	HERESH.M	hereshece2022@mvit.edu.in	Finished	23 mins 4 secs	25.5
22TC0176	DHAMODHARAN.S	dhamodharanece2022@mvit.edu.in	Finished	36 mins 26 secs	36
22TC0202	JANANI.P	jananiece2022@mvit.edu.in	Finished	40 mins 40 secs	25.5
22TC0172	DEEKSHITHA .M	deekshithaece2022@mvit.edu.in	Finished	15 mins 15 secs	32
22TC0255	PAVATHARANI .A	pavatharaniece2022@mvit.edu.in	Finished	35 mins 56 secs	32
22TC0270	ROSHINI.T	roshiniece2022@mvit.edu.in	Finished	28 mins 50 secs	26
22TC0207	JEEVITHA.M	jeevithaece2022@mvit.edu.in	Finished	18 mins 2 secs	26.5
22TC0253	NIRANJANA .S	niranjanaece2022@mvit.edu.in	Finished	1 hour 10 mins	19.5
22TC0182	MONICKA.E	monickaece2022@mvit.edu.in	Finished	12 mins 54 secs	31
22TC0169	BHUVANESHWARAN.S	bhuvaneshwaranece2022@mvit.edu.in	Finished	23 mins 1 sec	24
22TC0223	LAKSHMINARAYANARAJA .L	lakshminarayanarajaece2022@mvit.edu.in	Finished	19 hours 56 mins	36
22TC0231	MATHUBALA.M	mathubalaece2022@mvit.edu.in	Finished	36 mins 20 secs	33
22TC0158	ANAND.A	anandece2022@mvit.edu.in	Finished	37 mins 20 secs	33
22TC0312	VIJAY.P	vijayece2022@mvit.edu.in	Finished	33 mins 54 secs	34
22TC0151	AASISH BABU .B	aasishbabuece2022@mvit.edu.in	Finished	33 mins 50 secs	36
22TC0314	VINITHKUMAR.S	vinithkumarece2022@mvit.edu.in	Finished	31 mins 26 secs	30
22TC0239	MOHAMMED FAIZEL.R	mohammedfaizelece2022@mvit.edu.in	Finished	15 mins 25 secs	25.5
22TC0254	PARAMESWARI.S	parameswariece2022@mvit.edu.in	Finished	18 mins 4 secs	12
22TC0228	MADUMITHA.H	madumithaece2022@mvit.edu.in	Finished	12 days 19 hours 27 mins 1 sec	31
22TCL009	VAKKAPUTLA RAMU	vakkaputlarameuece2022@mvit.edu.in	Finished	26 mins 15 secs	31
22TC0257	PRADEEPRAJ.K	pradeeprajece2022@mvit.edu.in	Finished	5 mins 32 secs	35
22TC0190	HARINI.K	hariniece2022@mvit.edu.in	Finished	13 mins 50 secs	26.5
22TC0230	MATHEW SAMUEL.S	mathewsamuelece2022@mvit.edu.in	Finished	2 mins 50 secs	32
22TC0254	PARAMESWARI.S	parameswariece2022@mvit.edu.in	Finished	12 mins 19 secs	30
22TC0273	SABARISH.S	sabarishece2022@mvit.edu.in	Finished	8 mins 22 secs	16.5
22TCL002	MUBEEN ARAFATH	mubeenarfathece2022@mvit.edu.in	Finished	3 mins 29 secs	34
22TC0206	JAYASTEEN.J	jayasteenece2022@mvit.edu.in	Finished	4 mins 8 secs	30
22TC0162	ASWIN.H	aswinece2022@mvit.edu.in	Finished	6 mins 33 secs	36
22TC0165	BALASUBRAMANI .R	balasubramaniece2022@mvit.edu.in	Finished	13 mins 34 secs	30
22TC0315	VINOTH.V	vinothece2022@mvit.edu.in	Finished		33

22TC029	7	SUDHARSAN.T	sudharsanece2022@mvit.edu.in	Finished	2 mins	36
22TC019	7	HARISHKUMAR .K	harishkumarece2022@mvit.edu.in	Finished	1 min 59 secs	27
22TC029	9	SUMITHRAN.K	sumithranece2022@mvit.edu.in	Finished	8 days 23 hours	19.5
22TC030	4	THRISHA.V.L	thrishaece2022@mvit.edu.in	Finished	21 mins 14 secs	30
22TC018	0	DIVYA.D	divyaece2022@mvit.edu.in	Finished	11 mins 57 secs	34
22TC027	1	BHAVADHARANI.S.I	bhavadharaniece2022@mvit.edu.in	Finished	17 mins 50 secs	27
22TC015	9	ANBARASAN.S	anbarasanece2022@mvit.edu.in	Finished	13 mins 44 secs	31.5
22TC019	1	HARINI.E	harinieece2022@mvit.edu.in	Finished	31 mins 32 secs	35
22TC017	7	DHANANJAYAN.T	dhananjayanece2022@mvit.edu.in	Finished	7 mins 18 secs	34
22TC018	5	GEETHANJALI.T	geethanjali2022@mvit.edu.in	Finished	8 mins 42 secs	22.5
22TC015	5	AKSHAYA.A RANGALA LAXMI	akshayaece2022@mvit.edu.in	Finished	10 mins 29 secs	25
22TCL006		GANESH	rangalalaxmiganeshece2022@mvit.edu.in	Finished	47 mins 15 secs	30
22TC024	0	MOHANRAJ.R	mohanrajece2022@mvit.edu.in	Finished	7 mins 9 secs	36
22TC031	7	VISHNU PRABU.S	vishnuprabhuece2022@mvit.edu.in	Finished	6 mins 8 secs	33
22TC019	3	HARIRAJ RAJAVEL	harirajrajevece2022@mvit.edu.in	Finished	11 mins 8 secs	29.5
22TC019	8	HARSHIDHA.M	harshidhaece2022@mvit.edu.inh	Finished In progres s	5 mins 22 secs	32
22TC020	0	HERESH.M	hereshece2022@mvit.edu.in		-	-
22TC028	2	SAVITHA SRIVARSHINI.V	savithasrivarshiniece2022@mvit.edu.in	Finished	13 mins 20 secs	24.5
22TC024	5	NARASIMMAN.S	narasimmanece2022@mvit.edu.in	Finished	13 mins 46 secs	35
22TC020	8	JERINA BEGAM.A	jerinabegamece2022@mvit.edu.in	Finished	10 mins 15 secs	32
22TC018	3	ESWARI .P	eswariece2022@mvit.edu.in	Finished	2 mins 11 secs	14
22TC025	0	NAVEENRAJ.J	naveenrajece2022@mvit.edu.in	Finished	6 mins 10 secs	27
22TC021	9	KIRAN .O.K	kiranece2022@mvit.edu.in	Finished	1 min 43 secs	11
22TC019	5	HARISH.M	harishmece2022@mvit.edu.in	Finished	6 mins 59 secs	35
Overall average						29.25

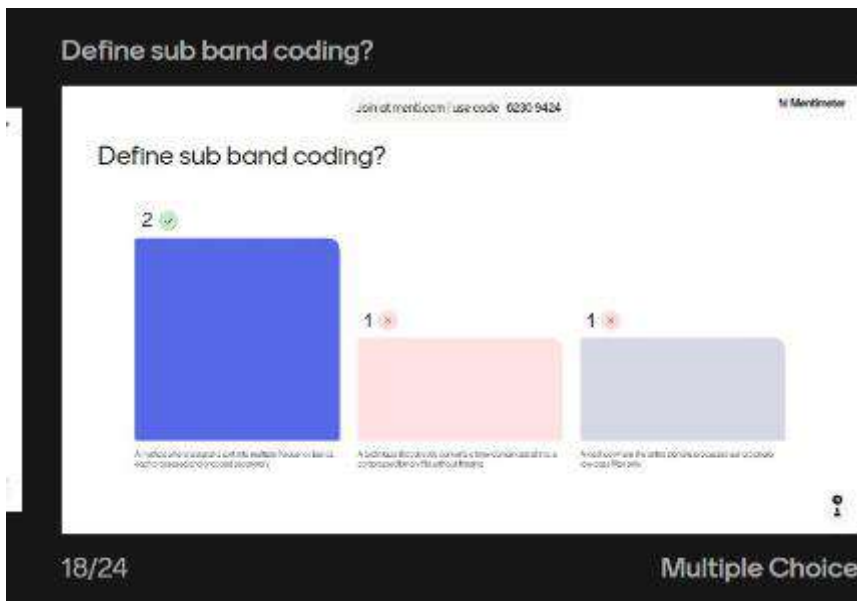
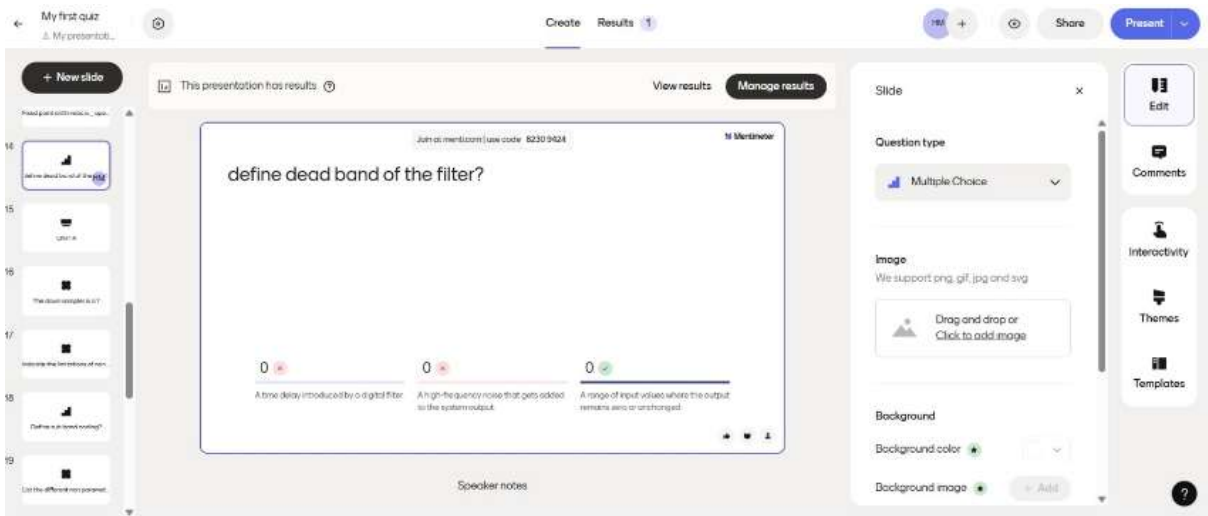
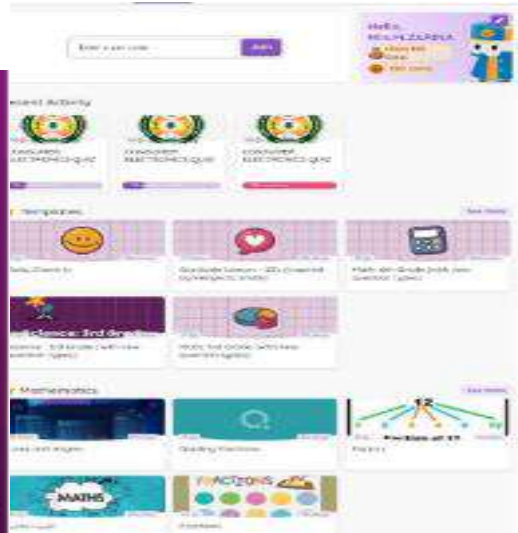

Tool Name: Quiz & Mentimeter, Purpose: To assess and reinforce student understanding of key MPMC concepts through interactive quizzes

Gidmind: Mind mapping

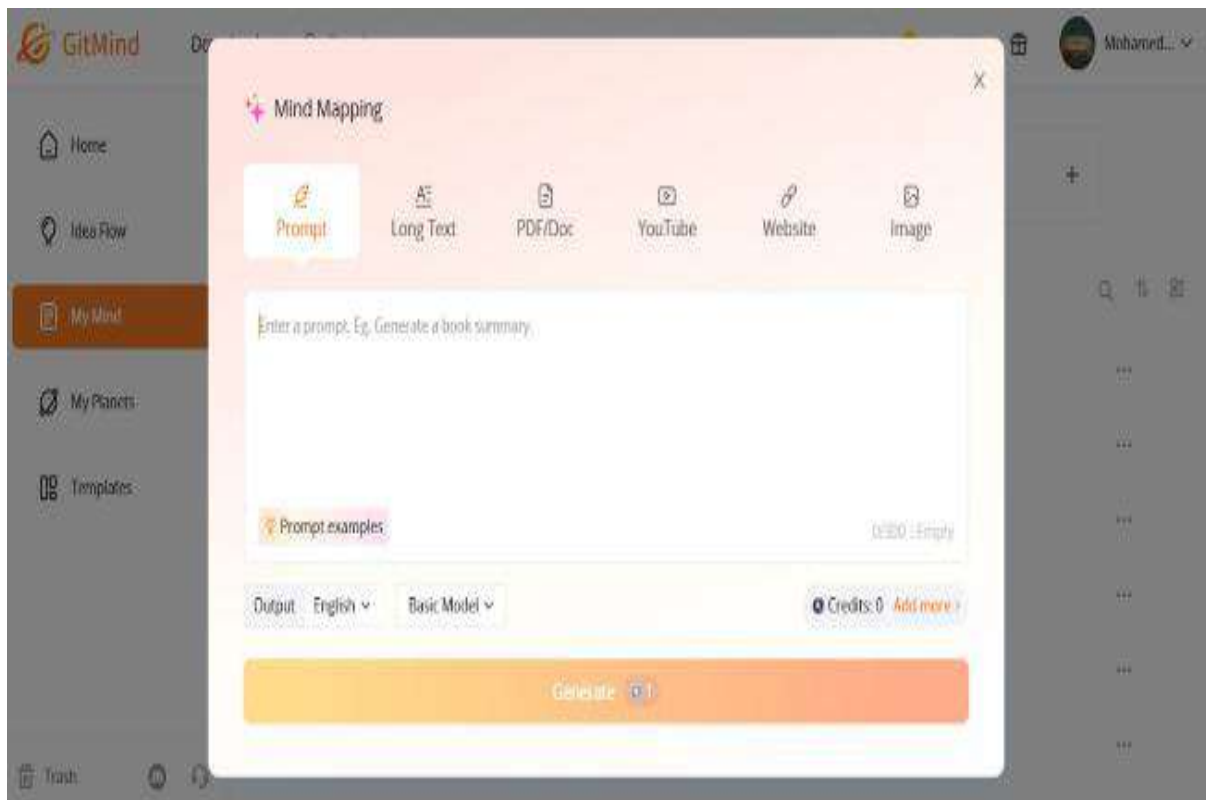

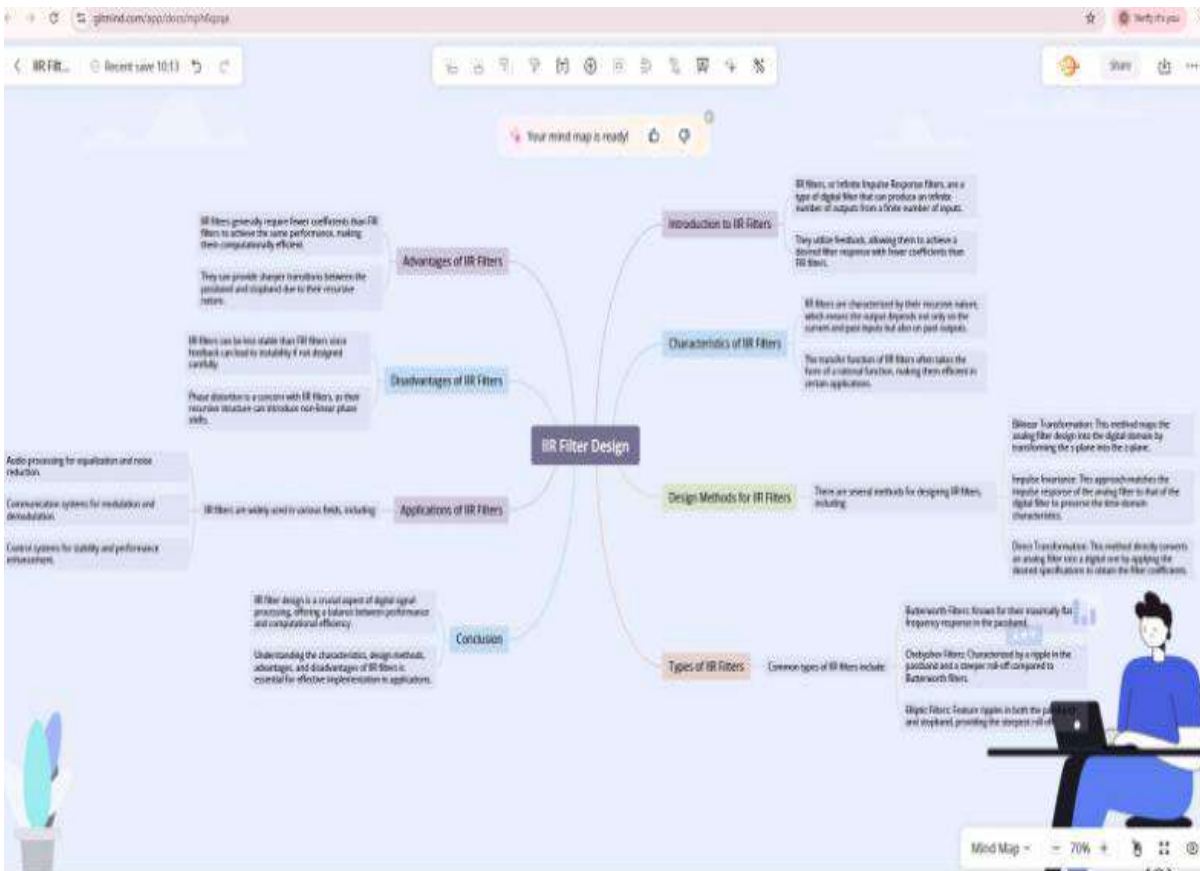

Tool Name: GidMind; Purpose: To create and visualize concept maps for simplifying complex topics in the subject.

WORDMINT



WordMint My Puzzles Support Browse My Account Sign Out

Print Export

Title: DSP Multiple Choice Questions (Last saved just now)

Header: Name, Date

Font Options Add Question

Name: _____ Date: _____

DSP Multiple Choice Questions

1. What does IIR stand for in digital filter design?
A. Infinite Impulse Response ✓ B. Initial Impulse Response
C. Inverse Impulse Response D. Intermediate Impulse Response
2. Which of the following is NOT a common realization structure for IIR filters?
A. Direct Form I B. Cascade Form
C. Wave Form ✓ D. Ladder Form
3. Why do IIR filters have feedback in their structure?
A. To reduce computational complexity B. To create an infinite impulse response. ✓
C. To minimize quantization errors D. To increase filter order
4. What is the primary advantage of Butterworth filters compared to Chebyshev filters?
A. Sharper cutoff frequency B. Lower computational complexity
C. Maximally flat response in the passband ✓ D. Better stopband attenuation
5. In bilinear transformation, which analog frequency maps to the digital frequency ω radians?
A. Infinite frequency ✓ B. Zero frequency
C. Nyquist frequency D. Half Nyquist frequency
6. When implementing a 4th order IIR filter in Direct Form I, how many delay elements are needed?

Tool Name: Word mint; Purpose: Word mint was used to deliver interactive lessons, quizzes, and multimedia content, puzzles and crossword enhancing student engagement and understanding of complex concepts in DSP.

Brainstorming Activity: Hot Seater

Digital signal processing

HOT SEATER

Brainstorming activity

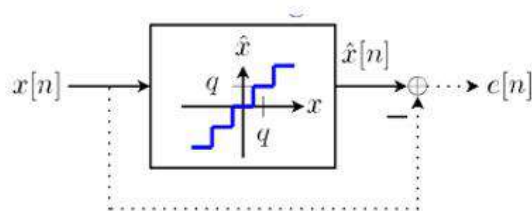

Related Block diagram

GUESS THE TYPE OF REALIZATION?

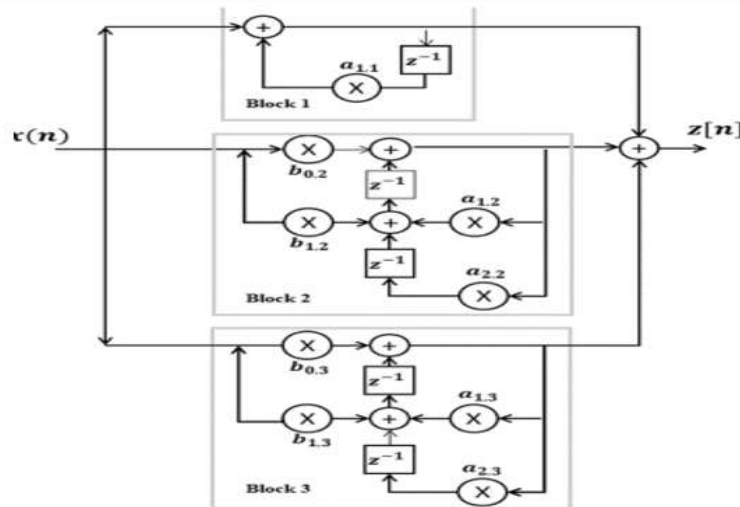

NAME THE WINDOW TECHNIQUE

Window function

$w(n), 0 \leq n \leq N$

1

$0.5 - 0.5 \cos\left(\frac{2\pi n}{N}\right)$

$0.5 - 0.46 \cos\left(\frac{2\pi n}{N}\right)$

$0.42 - 0.5 \cos\left(\frac{2\pi n}{N}\right) + 0.08 \cos\left(\frac{4\pi n}{N}\right)$

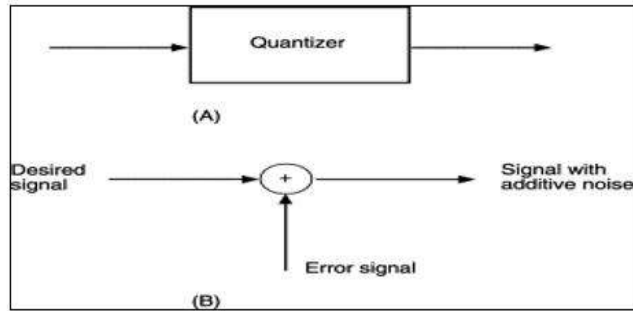

Related Block diagram

IDENTIFY THE FORMULAS

1) $\Omega = \frac{2}{T} \tan\left(\frac{\omega}{2}\right)$

2) $s = \frac{2}{T} \left[\frac{1-z^{-1}}{1+z^{-1}} \right]$

3) The order of the filter $N = \frac{\log \sqrt{\frac{10^{0.1\alpha_s} - 1}{10^{0.1\alpha_p} - 1}}}{\log \frac{\Omega_s}{\Omega_p}}$

Where α_s = stop band attenuation at stop band fr
 α_p = pass band attenuation at pass band fr

$s = \frac{2}{T} \left[\frac{1-z^{-1}}{1+z^{-1}} \right]$



Hot Seater; Purpose: Hot seater was used to deliver interactive lessons, and multimedia content, enhancing student engagement and understanding of complex concepts in DSP.

CHART WORK





Usage of PPT's for teaching